

**ALL INDIA INTER UNIVERSITY SEPAK TAKRAW (MEN) TOURNAMENT
2018-19 ORGANIZED BY KUVEMPU UNIVERSITY**

(Under the auspices of AIU New Delhi)

Kuvempu University is one of the youngest affiliating Universities in Karnataka. Established in 1987, it is a University with a distinctive academic profile, blending in itself commitment to rural ethos and a modern spirit. It has 50 Post-Graduate departments of studies in the faculties of Arts, Science, Commerce, Education and Law. The University has 106 affiliated colleges under its jurisdiction spread over two districts Shivamogga and Chickmagalore. It also has Four constituent colleges and outlying regional Post-Graduate center at Kadur.

The academic life on the campus is vibrant and exciting with seminars, symposia, special lectures and workshops throughout the year. Both the conventional and non-conventional courses of study have updated syllabi responsive to the needs of the contemporary society and the research orientation is innovative, original and directed to societal needs. The main campus is in the lap of a lush, picturesque locale providing the right ambience for University education. Indeed, Kuvempu University is a place one would love to be associated with.

Jnanasahyadri, the main campus of Kuvempu University is located at Shankaraghatta at a distance of 20 kms from Bhadravathi the well known industrial town and 28 kms from Shivamogga, the district head quarters. The campus is only 2 kms, from the magnificent Bhadra Reservoir across the river Bhadra, one of the important lifelines of the area. The main buildings of the University have been constructed on a small hillock, thus blending naturally with the landscape. The campus sprawls over an area of 230 acres. The entire campus area is free from any form of pollution including noise pollution. There is no exaggeration in saying that the undisturbed and pleasing atmosphere on the campus makes it ideally suited for the pursuit of higher education. The main campus can be reached by using the public/private bus services, from Shivamogga, Bhadravathi and Tarikere towns, which are close the campus and are well connected by rail.

Kuvempu University is a very vibrant place of higher learning with many academic and cultural activities. The University houses on its main campus at Jnanasahyadri, Shankaraghatta with several Post Graduate departments of studies and research.

INSTRUCTIONS TO THE PARTICIPATING TEAMS

- A meeting of the Team Managers will be held at the venue (Prof. Venkataramaih Hall) at **05.00 pm on 16th February 2019**. All the Team managers are requested to attend the meeting with out fail.
- Reception counter will be functioning at Jnanasahyadri, shankarghatta. From 10.00 am 16/02/2019 onwards for the teams staying on the campus
- All the participating teams are requested to inform their arrival date, time and the mode of transport to the Organizing Secretary well in advance through e-mail.
- Unfurnished Accommodation will be provided to the participating team. Each team should deposit a sum of **Rs.2000/-** (Two thousand only) as caution deposit.

- The weather on the campus is very pleasant during February; light warm clothing's are advisable to players/officials accompanying them.
- The Tournament will be played as per the Sepaktakraw Federation of India as adopted by the AIU, New Delhi. If team consists of five players they can play Regu and Doubles. If the team consists of eight players separate team should be given for Regu and Doubles and the players are not allowed to inter change after the entry is given.
 - The official's decision shall be final and binding at all stages of the Tournament.
 - It will be the sole responsibility of the Mangers to maintain absolute discipline among their team members.
 - The team managers are requested to hand over the following documents to the Organizing Secretary, immediately on their arrival at the venue in the reception counter.

- a) Eligibility Performa (Four copies)
- b) Latest identity Cards of the players duly signed by the competent authority of their University.
- c) University Flag (Two numbers) for March past.
- d) Attested copies of SSLC, PUC Marks cards, Degree marks cards incase of PG students, copy of this year's admission receipt.

- Officiating charges **Rs.1500/-** per match per team shall be charged.
- The organizing committee reserves the rights to make changes in the program to suit its convenience. The decision of the organizing committee shall be final with regard to matters concerning the tournament.
- **All Teams have to participate in the In the Inaugural function at.10.00 am on 17th February 2019 along with their university flags.**
- **The Fixtures will be released in Kuvempu.ac.in official website on 22nd January 2019.**

Inquiry regarding the tournament & Accommodation:

Mr.G S Nagaraj – Dy. Director of Phy. Edn. (Technical)	09448782095
Dr. N D Virupaksha – Dy. Director of Phy. Edn. (Eligibility)	09481877431
Dr. Appanna M Gasti – Dy. Director of Phy. Edn. (Reception)	09449757038
Dr. Gajanana Prabhu B– Asst. Prof. (Publicity &Results)	09845311458
Dr. Ravindragouda S M –(Accommodation) 08310453346 or	09886852688
Mr. Vileep - Faculty - (Technical - Tournament)	09483587857
Mr. Prasad - Faculty - (Technical - Tournament)	09449064096
Mr. Shankarmurthy – Faculty – (Accommodation)	09980289318
Mr. Balakrishna – Faculty – (Accommodation)	09845395552
Mr. Sanjeeva - Faculty - (Food)	08618652400
Mr. Sampathkumar - Faculty - (Food)	09110821778
Dr. Shivakumara S - Faculty - (Transportation)	09611600331
Miss.Tangarani – Faculty – Reception	09986368917
Mrs. Rekha - Faculty - Reception	09035635651

HOW TO REACH SHIVAMOGGA

Shivamogga is well connected By Road (N.H. 13 Sollarapur-Mangalore and N.H. 206 Bangalore-Honnavar) and by train (**SOUTH WESTERN RAILWAY**). Shivamogga Town Railway station is under the SOUTH-WESTERN RAILWAY. Shivamogga town railway station is 63 kms. from Birur Junction which links Bangalore-Pune main line. Teams travelling by trains from north via Hubli and travelling from south via Bangalore should get down at Birur junction and travel by connecting trains from Birur to Shivamogga or by bus. Daily 4 Direct trains are from Bangalore to Shivamogga and numbers of trains are available up to Birur junction. The detailed chart is enclosed for your ready reference. **For the exact timings of the train, please refer new railway time table.**

- 1) Birur Junction –Shivamogga Town
- 2) Bangalore to Birur-Shivamogga Town (From South)
- 3) Hubli to Birur Junction – From North (Trains from Nizammuddin, Jodhpur, Ajmir, Mumbai, Pune, Miraj, Hubli)

1. TRAIN SCHEDULE FROM BIRUR TO SHIVAMOGGA*

Sl. No	Train No.	Train Name	Arrival Birur (hrs.)	Departure Birur (hrs.)	Arrival at Shivamogga (hrs.)	Remarks.
01	6227	Bangalore-Shivamogga Town Express	03.03	03.05	04.55	Direct train from Bangalore at 23-00 Hrs.
02	578	Birur-Shivamogga Town Passenger	-----	08.00	0.50	Start from Birur
03	575	Bangalore-Shivamogga Town Fast Passenger	10-50	11-20	13-10	Departure Bangalore at 06.40 Hrs.
04	268	Mysore –Shivamogga Town Fast Passenger	14-13	14-15	16-25	Departure Mysore at 10-15 hrs.
05	280	Birur – Shivamogga Town Passenger	-----	18-20	20-10	Bangalore-Hubli Inter city express connecting Train
06	227	Bangalore-Shivamogga Town Passenger	20-58	21-00	23-00	Departure Bangalore at 15-45 Hrs.

*Trains current timing can be obtained from new railway time table 2010

2. TRAIN SCHEDULE FROM SOUTH (Via Bangalore)*

Sl. No	Train No.	Trains Name	Departure Bangalore (hrs.)	Arrival at Birur (hrs.)	Remarks
01	2079	Bangalore-Hubli Jan Shatabdi Express	06-00	09-03	Except Tuesday
02	1018	Bangalore-Dadar Calukya Express	06-20	10-08	Except Tuesday
03	587	Bangalore –Shivamogga	06-40	10-50	Arrival

		Town Fast Passenger			Shivamogga at 13-10
04	581/591	Bangalore-Dharwar/Chitradurga Passenger	07-55	13-03	-----
05	2725	Bangalore-Hubli Intercity Express	14-30	17-53	-----
06	7309	Yashvantpur-Vasco da gama Express (Departure from Yashvantpur)	15-15	18-53	-----
07	227	Bangalore-Shivamogga Town Passenger	15-45	21-00	Arrival Shivamogga at 23-00
08	62-17	Mysore-H-Nizamudding Swarna Jayanthi Express.	19-45 (Departure time from Bangalore)	23-33	Friday Only
09	6589	Bangalore-CSM(Kollapur) Rani Channamma Express	21-00	12.53	-----
10	6506	Bangalore- Gandhidham Express	21-25	01-23	Saturday Only
11	6508	Bangalore –Jodhpur Express	21-25	01-23	Monday, Wednesday.
12	6510	Bangalroe-Ajmeer Express	21-25	01-23	Tuesday, Thursday
13	7311	Chennai-Vascodagama Express	21-00 Departure time from Yashwantpur	01-23	Friday.
14	7313	Chennai-Hubli Express	21-00 Departure time from Yashwantpur	01.23	Sunday.
15	6227	Bangalore-Shivamogga Town Express	23-00	03-00	Arrival Shivamogga at 4.55
16	583/583	Bangalore-Hospet. Hubli Fast Passenger	22-00	02-15	----

3. TRAIN SCHEDULE FROM NORTH*
(Train from Hubli, Miraj, Pune, Mumbai, Ahamabad)

Sl. No	Train No.	Trains Name	Depart ure (hrs.)	Arrival at Birur (hrs.)	Remarks
01	2080	Hubli-Bangalore Intercity Express	06-20	10-05	-----
02	2080	Hubli-Bangalore Jan Shatabdi Express	13-30	16-53	-----
03	1017	Dadar-Bangalore Chalukya Express	14-30	18-08	Except Tuesday (Via Pune-Miraj)
04	1035	Dadar-Mysore Sharavathi Express	14-30	18-08	Tuesday Only

05	5605	Gandhidham-Bangalore Express	17-30	21-58	(Departure from Gandhidham on Tuesday at 08.20 Via Ahamadabad, Kalyan, Pune Miraj)
06	6507	Jodhur-Bangalore Express	17-30	21-58	(Departure from Jodhpur on Tuesday & Saturday 05-30 Via Ahmedabad, Kalyan, Pune, Miraj)
07	6509	Ajmer-Bangalore Express	17-30	21-58	(Departure from Ajmir on Friday, Sunday 05-35. Via Ahamadabad, Kalyan, Pune, Miraj)
08	6202	Dharwad-Mysore Express	20-15	00-58	
09	7314	Hubli-Chennai Express	20-50	01-13	Saturday only
11	6590	Kolhapur-Bangalore Rani Chennamma Express	22-05	02-28	Departure Kollapur 14-00 Miraj 15-45
12	6218	Nizamuddin-Mysore Swarnajayanthi Express	22-50	03.08	Departure from Niamuddin on Monday at 05.50 Via Bhopal, Itrasi, Manmad, Pune, Miraj, Hubli)
13	7310	Vascodagama-Yeshvanthpur Express	02-15	06-08	Departure from Vasco on Monday, Saturday at 20-30 on Via Londa, Hubli
14	2730	Nizamuddin-Vasco da gama Goa Express	05-10 (Arrival at Hubli)		Departure from Nizamuddin 15-00 Via Bhopa, Itarzi, Manmad, Daund, Pune, Miraj, Londa upto Hubli

*Trains current timing can be obtained from new railway time table 2010

SHIVAMOGGA:

Shivamogga is situated in South Central part of Karnataka. Shivamogga is called as gate way of Malnad (Forest Area) and Shivamogga city in well known as Areca City. Town is on the bank of Holy River Tunga.

Place of Tourist around Shivamogga.

- | | |
|---|---------|
| 1) Bangalore | 274 kms |
| 2) Mysore | 274 kms |
| 3) World famous Jog falls | 105 kms |
| 4) Sri Sharadha Peeta, Sringeri | 106 kms |
| 5) Kemmannugundi (Hill station) | 65 kms |
| 6) Udupi (Lord Sri Krishna Temple) | 140 kms |
| 7) Dharmasthala (Lord Sri Manjunatheshwara Temple) | 200 kms |

Date: January 19, 2019.
Place: Shankaraghatta – 577451

(Dr. S M Prakash)
Organizing Secretary

ALL-INDIA INTER-UNIVERSITY SEPAK TAKRAW MEN TOURNAMENT 2018-19

Organised By- Department of Physical Education, Kuvempu University,
Jnanasahyadri, Shankaraghatta, Shivamogga-577 451

REGU FIXTURES (MEN)

Group A

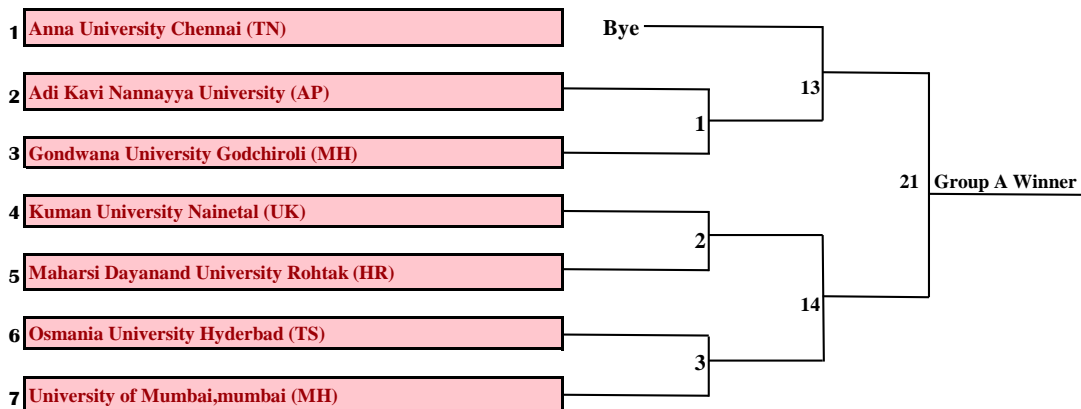

Group B

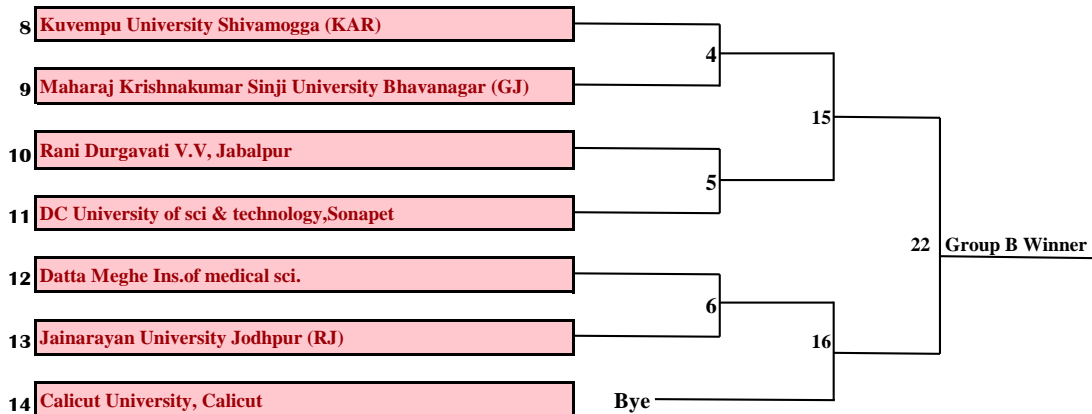

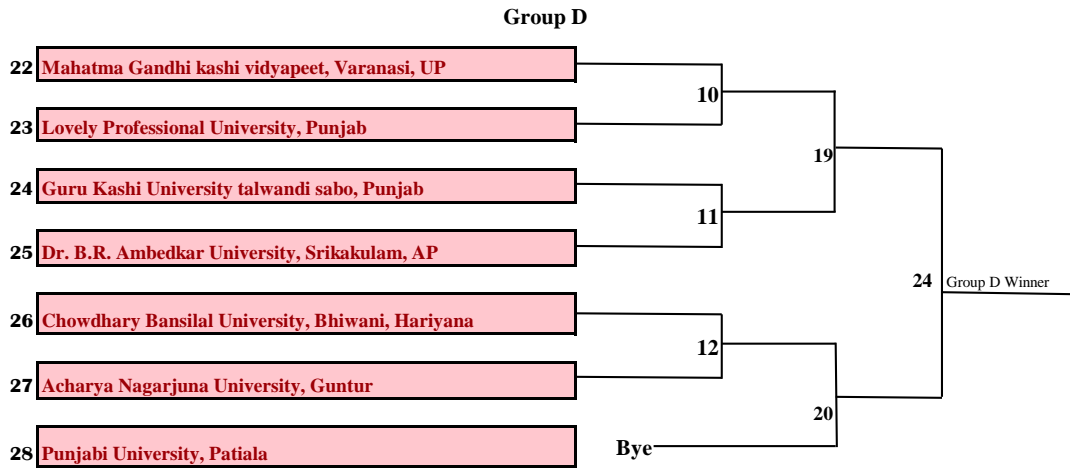
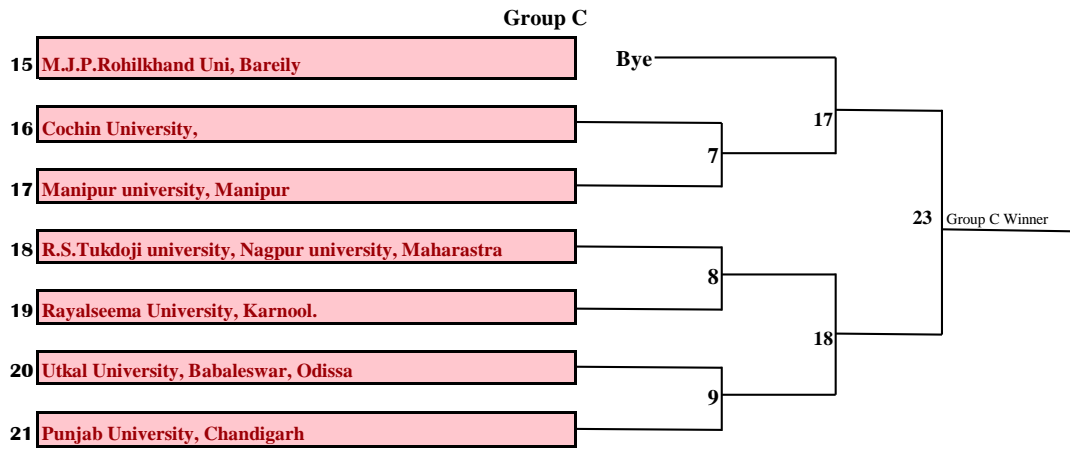

League Match Fixture

- Group A Winner V/S Group B Winner
- Group C Winner V/S Group D Winner
- Group A Winner V/S Group C Winner
- Group B Winner V/S Group D Winner
- Group A Winner V/S Group D Winner
- Group B Winner V/S Group C Winner

(Dr. S M Prakash)
Organizing Secretary &
Director of Physical Education

ALL-INDIA INTER-UNIVERSITY SEPAK TAKRAW MEN TOURNAMENT 2018-19

Organised By- Department of Physical Education, Kuvempu University,
Jnanasahyadri, Shankaraghatta, Shivamogga-577 451

DOUBLES FIXTURE (MEN)

Group A

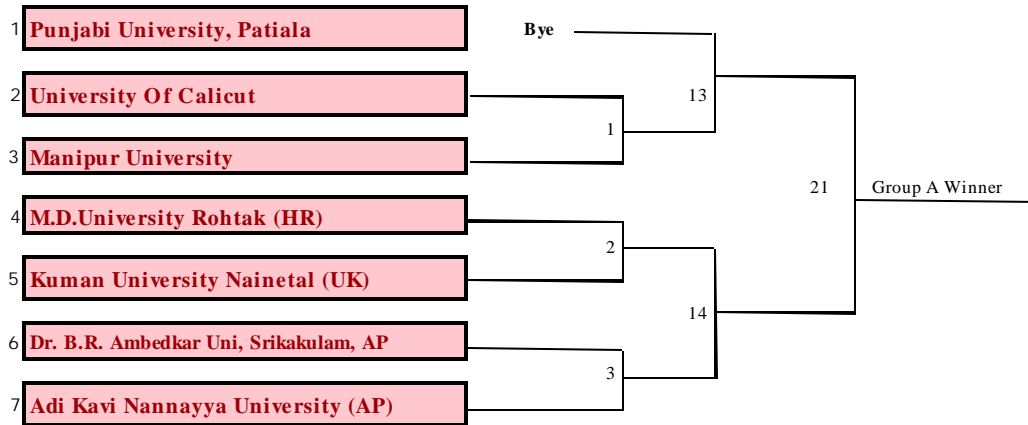

Group B

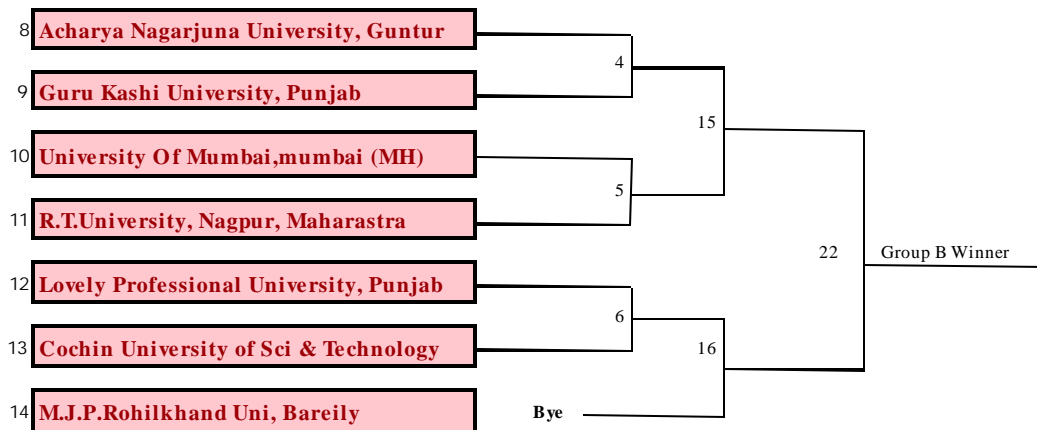

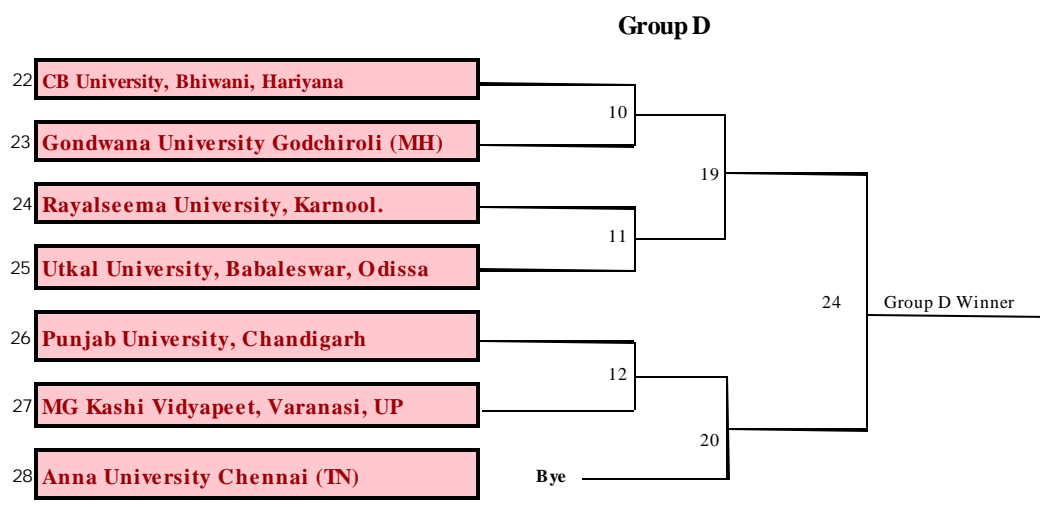
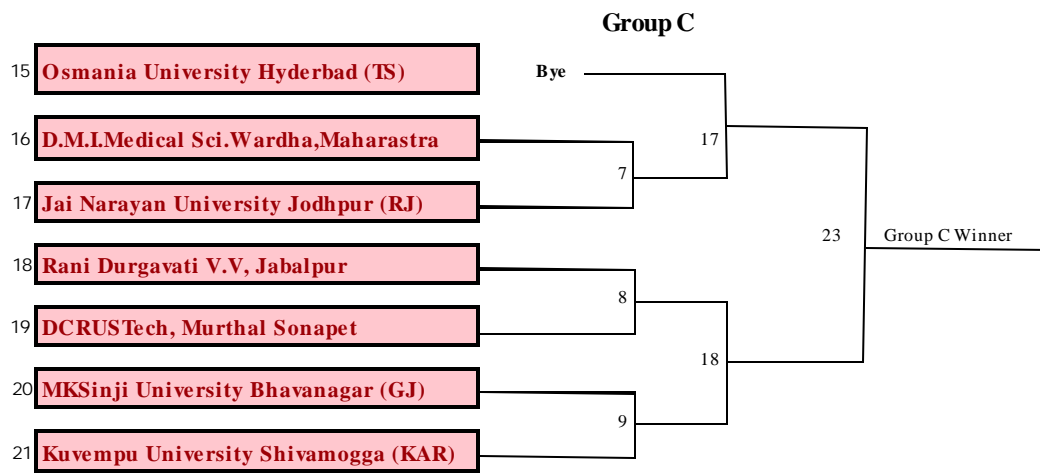

League Match Fixtures

- Group A Winner V/S Group B Winner
- Group C Winner V/S Group D Winner
- Group A Winner V/S Group C Winner
- Group B Winner V/S Group D Winner
- Group A Winner V/S Group D Winner
- Group B Winner V/S Group C Winner

(Dr. S M Prakash)
Organizing Secretary &
Director of Physical Education

KUVEMPU  UNIVERSITY

ALL INDIA INTER UNIVERSITY SEPAK TAKRAW (Men) CHAMPIONSHIPS 2018-2019

DATES: 17TH TO 19TH FEBRUARY 2019

VENUE: INDOOR SPORTS COMPLEX

MEN'S REGU MATCHES SCHEDULE

DATES	TIMINGS	MATCH NUMBERS
17/02/2019	7.00 AM TO 10.00 AM	1 TO 10
OPENING CEREMONY	10.30 AM TO 11.30 AM	ASSEMBLY OF ALL TEAMS
17/02/2019	12.00 AM TO 1.30 PM	11-15
17/02/2019	1.30 PM TO 3.00 PM	LUNCH BREAK
17/02/2019	3.00 TO 5.00 PM	16 TO 20
17/02/2019	5.00 PM TO 7.00 PM	21-24
19/02/2019 9.00 AM To 12.00	Group A Winner V/s Group B Winner Group C Winner V/s Group D Winner Group A Winner V/s Group C Winner Group B Winner V/s Group D Winner Group A Winner V/s Group D Winner Group B Winner V/ S Group C Winner	SUPER LEAGUE MATCHES OF TOP TEAMS IN ALL GROUPS

**(S M PRAKASH)
ORGANIZING SECRETARY &
DIRECTOR OF PHYSICAL EDUCATION**

KUVEMPU  UNIVERSITY

ALL INDIA INTER UNIVERSITY SEPAK TAKRAW (Men) CHAMPIONSHIPS 2018-2019

DATES: 17TH TO 19TH FEBRUARY 2019

VENUE: INDOOR SPORTS COMPLEX

MEN'S DOUBLES MATCHES SCHEDULE

DATES	TIMINGS	MATCH NUMBERS
OPENING CEREMONY	10.30 AM TO 11.30 AM	ASSEMBLY OF ALL TEAMS
17/02/2019	12.00 AM TO 1.30 PM	1-10
17/02/2019	1.30 PM TO 3.00 PM	LUNCH BREAK
17/02/2019	3.00 TO 5.00 PM	11-20
17/02/2019	5.00 PM TO 7.00 PM	21-24
19/02/2019 9.00 AM To 12.00	Group A Winner V/s Group B Winner Group C Winner V/s Group D Winner Group A Winner V/s Group C Winner Group B Winner V/s Group D Winner Group A Winner V/s Group D Winner Group B Winner V/ S Group C Winner	SUPER LEAGUE MATCHES OF TOP TEAMS IN ALL GROUPS

**(S M PRAKASH)
ORGANIZING SECRETARY &
DIRECTOR OF PHYSICAL EDUCATION**